

DE

Legende (LAS)

Max. Gravurbereich

Max. Motivgröße

Bitte beachten Sie, daß wir aus produktionstechnischen Gründen standardgemäß folgende **maximale Motivgrößen** von

- bis zu **800 mm² (LAS 8)** oder
- bis zu **1700 mm² (LAS 17)** oder
- bis zu **2600 mm² (LAS 26)** oder
- bis zu **3500 mm² (LAS 35)** anbieten.

Motive über 3500 mm² müssen angefragt und auf Umsetzbarkeit geprüft werden.
Eine maximale Motivgröße von 140 x 140 mm darf nicht überschritten werden.

Aufgrund der Artikeloberflächenbeschaffenheit können wir eine 100%ige Farb- und Standgenauigkeit nicht garantieren. Dies gilt insbesondere für Wiederholungsaufträge.

Änderungen der Vorlagen aus technischen Gründen behalten wir uns vor!

EN

Legend (LAS)

Max. engraving area

Max. motif size

Please note that for production reasons we offer following **maximum motif sizes** of

- up to **800 mm² (LAS 8)** or
- up to **1700 mm² (LAS 17)** or
- up to **2600 mm² (LAS 26)** or
- up to **3500 mm² (LAS 35)** as standards.

Motifs larger than 3500 mm² must be requested and checked for feasibility.
A maximum motif size of 140 x 140 mm must not be exceeded.

Due to the nature of the item's surface, we cannot guarantee 100% colour and stand accuracy. This is especially true for repeat assignments.

We reserve the right to make changes to the templates for technical reasons!

52655
RETUMBLER-NIZZA II 600 CERAMIC

Thermo drinking bottle

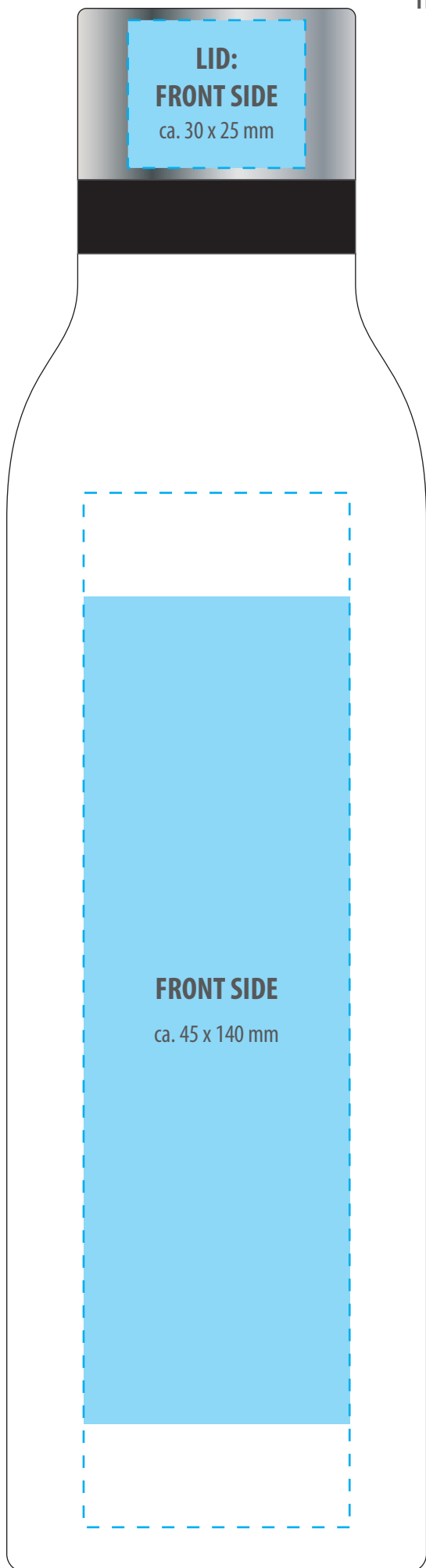

LID:
FRONT SIDE
ca. 30 x 25 mm



LID:
TOP SIDE
ca. 40 mm Ø

FRONT SIDE
ca. 45 x 140 mm

52655
RETUMBLER-myNIZZA II 600 CERAMIC

Thermo drinking bottle

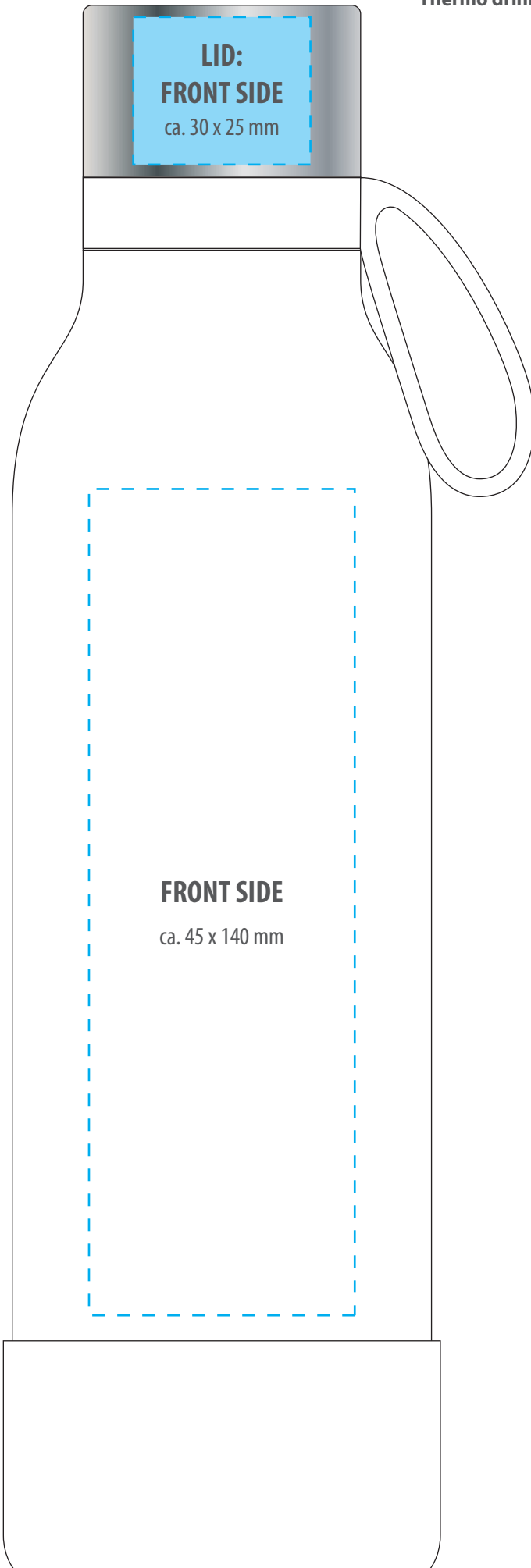

LASER ENGRAVING (LAS)

Configuration:

- BOTTLE:
52655-X
- RING:
52457-R
- SLEEVE:
52457-S

52655
RETUMBLER-myNIZZA II 600 CERAMIC

Thermo drinking bottle

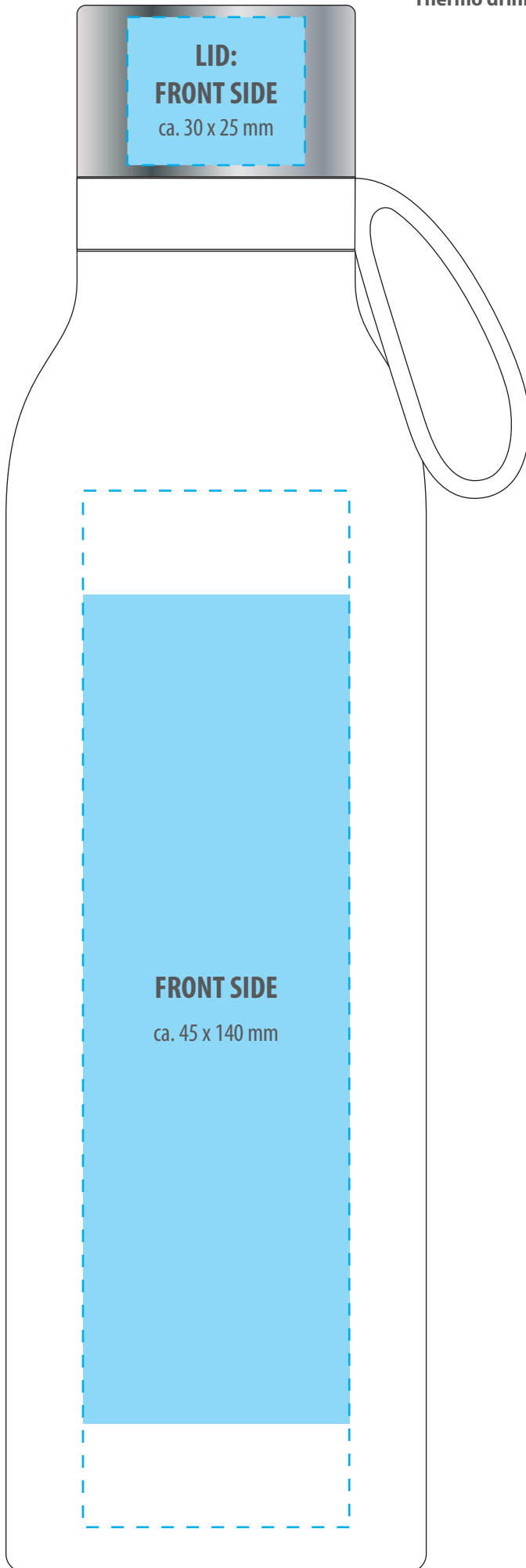

LID:
FRONT SIDE
ca. 30 x 25 mm



LID:
TOP SIDE
ca. 40 mm Ø

FRONT SIDE
ca. 45 x 140 mm

Configuration:

- BOTTLE:
52655-X
- RING:
52457-R

LASER ENGRAVING (LAS)

52655
RETUMBLER-myNIZZA II 600 CERAMIC

Thermo drinking bottle

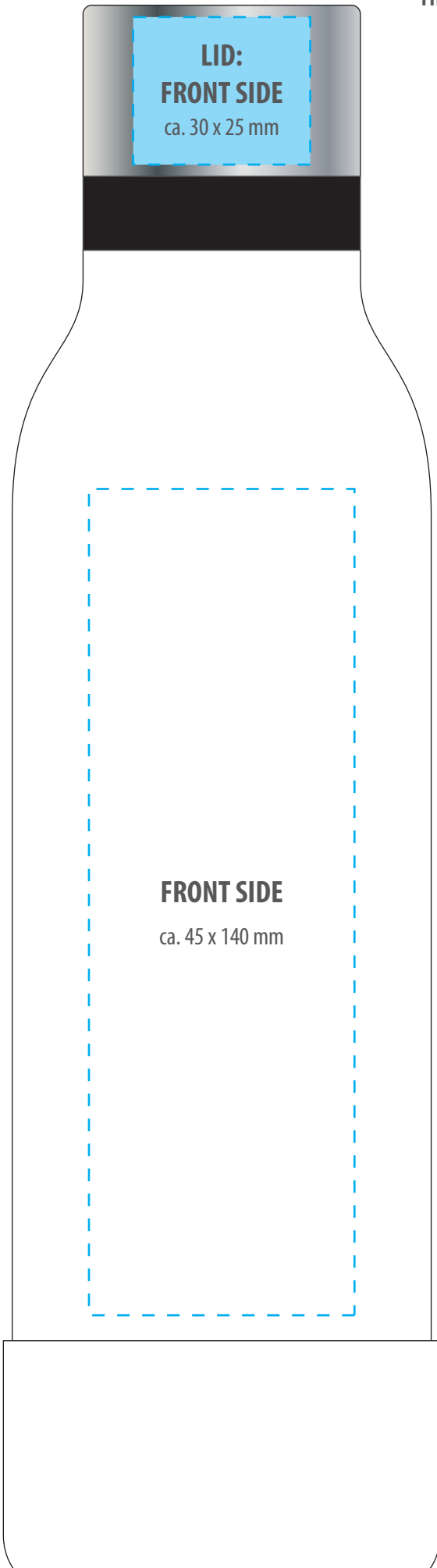

LASER ENGRAVING (LAS)

Configuration:

- BOTTLE
+ RING:
52655-X
- SLEEVE:
52457-S

DE

Legende (TAM)



Max. Druckbereich

Max. Motivgröße

Bitte beachten Sie, daß wir aus produktionstechnischen Gründen folgende **maximale Motivgrößen** anbieten:

- **60 x 60 mm** oder
- **80 x 40 mm** oder
- **150 x 150 mm** oder
- **200 x 200 mm**

Größere Motive müssen in mehreren Durchgängen gedruckt werden und werden als mehrere Positionen gehandelt. Diese bitte vorab anfragen.

Aufgrund der Artikeloberflächenbeschaffenheit können wir eine 100%ige Farb- und Standgenauigkeit nicht garantieren. Dies gilt insbesondere für Wiederholungsaufträge.

Auch die Lesbarkeit besonders feiner Schriften sowie die Passgenauigkeit bei mehrfarbigen Drucken kann durch die Artikeloberflächenbeschaffenheit beeinträchtigt werden! Beachten Sie weiterhin, daß es beim Druck von hellen Farben auf dunkle Artikel zu Farbabweichungen kommen kann. Dies kann durch einen Doppeldruck oder weiße Unterlegung (Anzahl der Druckfarben ändert sich ggf.) vermieden werden.

Änderungen der Vorlagen aus technischen Gründen behalten wir uns vor!

EN

Legend (TAM)



Max. print area

Max. motif size

Please note that for production reasons we offer the following **maximum motif sizes**:

- **60 x 60 mm** or
- **80 x 40 mm** or
- **150 x 150 mm** or
- **200 x 200 mm**

Larger motifs must be printed in several passes and are traded as several items. Please enquire about these in advance.

Due to the nature of the item's surface, we cannot guarantee 100% colour and stand accuracy. This is especially true for repeat assignments.

The readability of particularly fine fonts as well as the fitting accuracy of multicoloured prints can also be affected by the article surface texture!

Please also note that colour deviations may occur when printing light colours on dark articles. This can be avoided by a double print or white underlay (number of print colours may change).

We reserve the right to make changes to the templates for technical reasons!

52655
RETUMBLER-NIZZA II 600 CERAMIC



Thermo drinking bottle

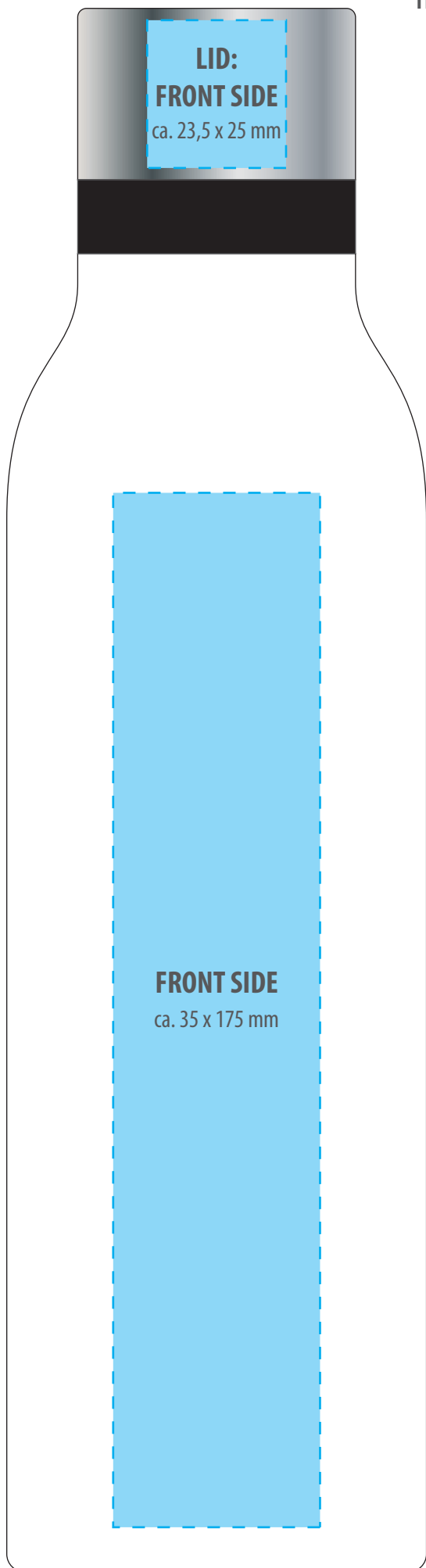

LID:
FRONT SIDE
ca. 23,5 x 25 mm

FRONT SIDE
ca. 35 x 175 mm



LID:
TOP SIDE
ca. 40 mm Ø

Printing colors:



Color 1



Color 2

PAD PRINT (TAM)

52655
RETUMBLER-myNIZZA II 600 CERAMIC



Thermo drinking bottle

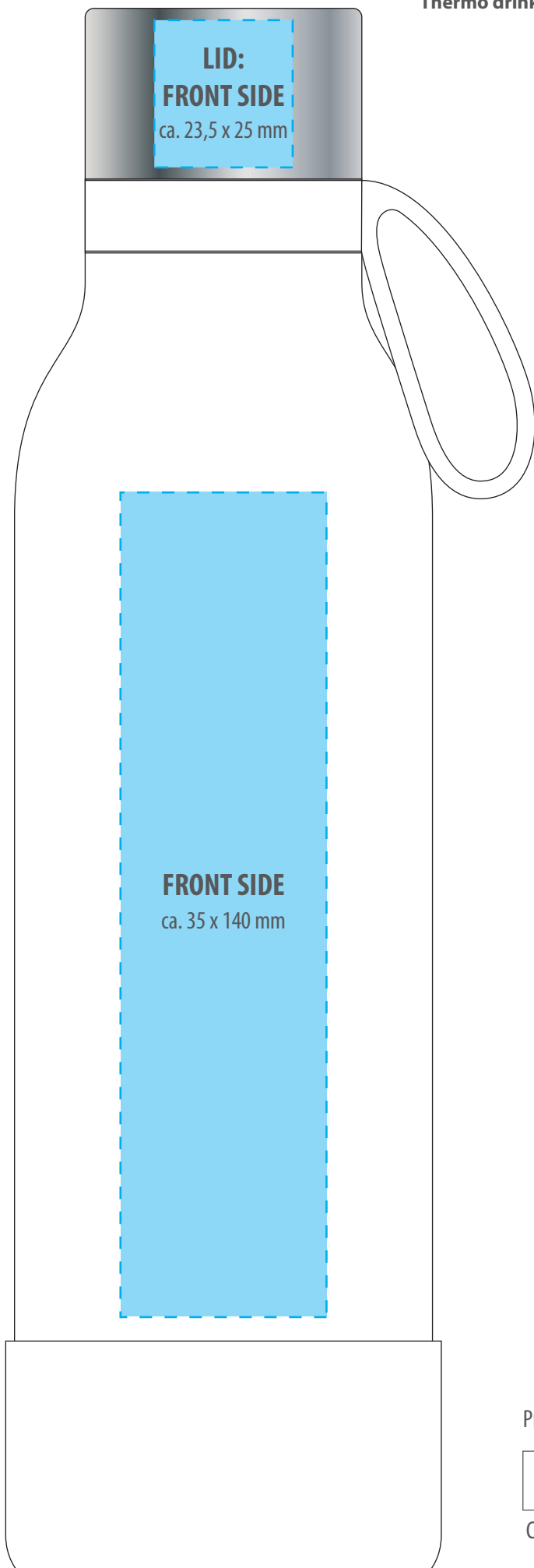

LID:
FRONT SIDE
ca. 23,5 x 25 mm



LID:
TOP SIDE
ca. 40 mm Ø

FRONT SIDE
ca. 35 x 140 mm

Printing colors:



Color 1



Color 2

Configuration:

- BOTTLE:
52655-X
- RING:
52457-R
- SLEEVE:
52457-S

PAD PRINT (TAM)

52655
RETUMBLER-myNIZZA II 600 CERAMIC



Thermo drinking bottle

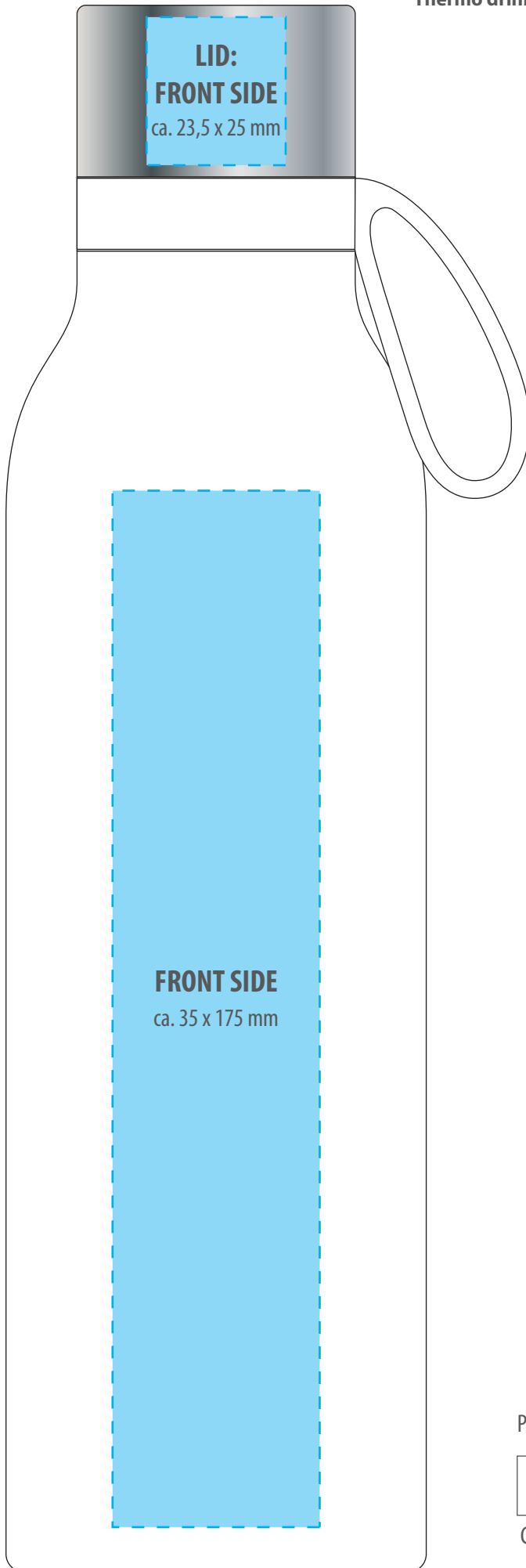

LID:
FRONT SIDE
ca. 23,5 x 25 mm



LID:
TOP SIDE
ca. 40 mm Ø

FRONT SIDE
ca. 35 x 175 mm

Printing colors:



Color 1



Color 2

Configuration:



BOTTLE:
52655-X



RING:
52457-R

PAD PRINT (TAM)

52655
RETUMBLER-myNIZZA II 600 CERAMIC



Thermo drinking bottle

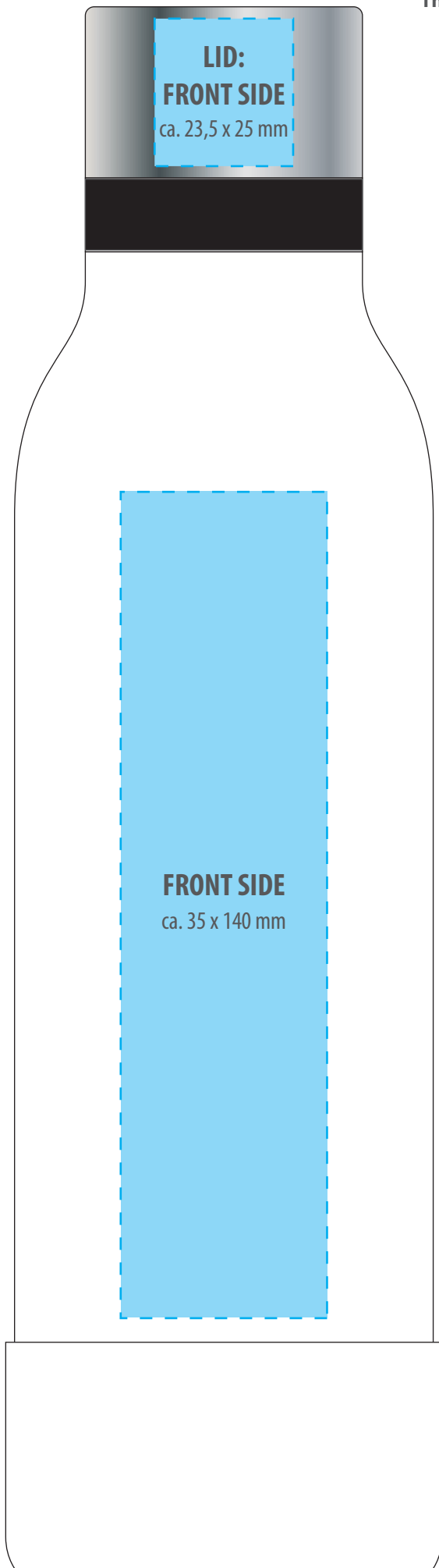

LID:
FRONT SIDE
ca. 23,5 x 25 mm



LID:
TOP SIDE
ca. 40 mm Ø

FRONT SIDE
ca. 35 x 140 mm

Printing colors:

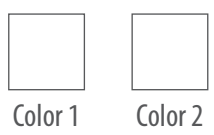

Configuration:

- BOTTLE + RING: 52655-X
- SLEEVE: 52457-S

PAD PRINT (TAM)

DE

Legende (UVD)

Max. Druckbereich = Max. Motivgröße

Bitte beachten Sie, daß aus produktionstechnischen Gründen das Druckmotiv an abfallenden Kanten und Vertiefungen verzerrt oder blasser werden kann.

Bei nicht durchgehenden Oberflächen (z. B. Tasten, Abdeckklappen oder Adaptersteckern) kann es im Alloverdruck zu Motivunterbrechungen bzw. einem unvollständigen Druckbild kommen. Berücksichtigen Sie dies bei der Platzierung wichtiger Motivbestandteile, wie Logos und Texten. Die Hintergrundgestaltung kann bis zum Rand des max. Druckbereiches reichen.

Aufgrund der Artikeloberflächenbeschaffenheit können wir eine 100%ige Farb- und Standgenauigkeit nicht garantieren. Dies gilt insbesondere für Wiederholungsaufträge.

Änderungen der Vorlagen aus technischen Gründen behalten wir uns vor!

EN

Legend (UVD)

Max. print area = max. motif size

Please note that for technical production reasons the print motif may be distorted or faded on sloping edges and indentations.

In the case of non-continuous surfaces (e.g. buttons, cover flaps or adapter plugs), all-over printing may result in interruptions in the motif or an incomplete printed image. Take this into account when placing important motif components such as logos and texts. The background design can extend to the edge of the maximum print area.

Due to the nature of the item's surface, we cannot guarantee 100% colour and stand accuracy. This is especially true for repeat assignments.

We reserve the right to make changes to the templates for technical reasons!

52655
RETUMBLER-NIZZA II 600 CERAMIC



Thermo drinking bottle

52655-BK AND -WE ONLY!

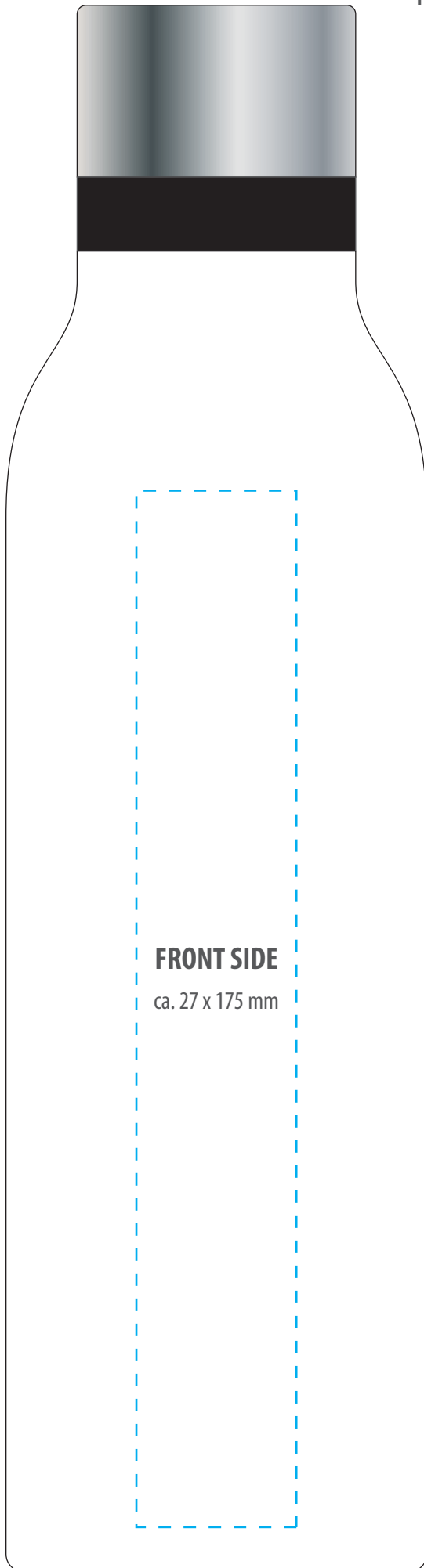

FRONT SIDE
ca. 27 x 175 mm

Printing colors:



CMYK

UV DIGITAL PRINT (UVD)

52655
RETUMBLER-myNIZZA II 600 CERAMIC



Thermo drinking bottle

52655-BK AND -WE ONLY!

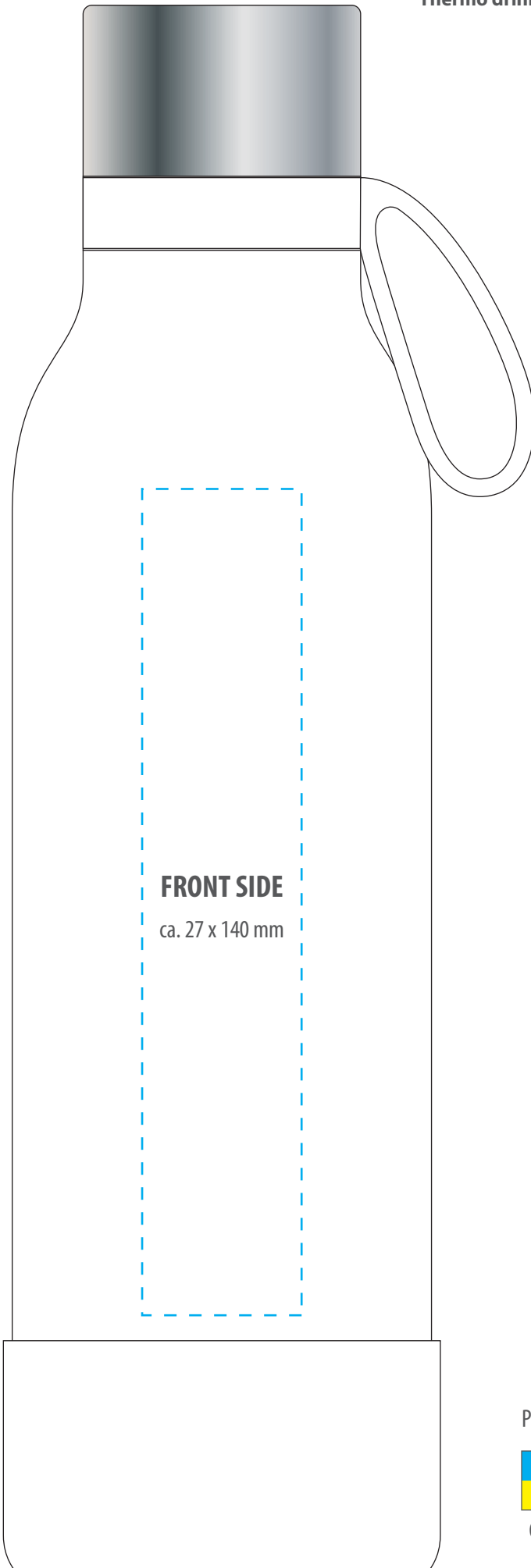

FRONT SIDE

ca. 27 x 140 mm

Printing colors:



CMYK

Configuration:

- BOTTLE:
52655-X
- RING:
52457-R
- SLEEVE:
52457-S

UV DIGITAL PRINT (UVD)

52655
RETUMBLER-myNIZZA II 600 CERAMIC



Thermo drinking bottle

52655-BK AND -WE ONLY!

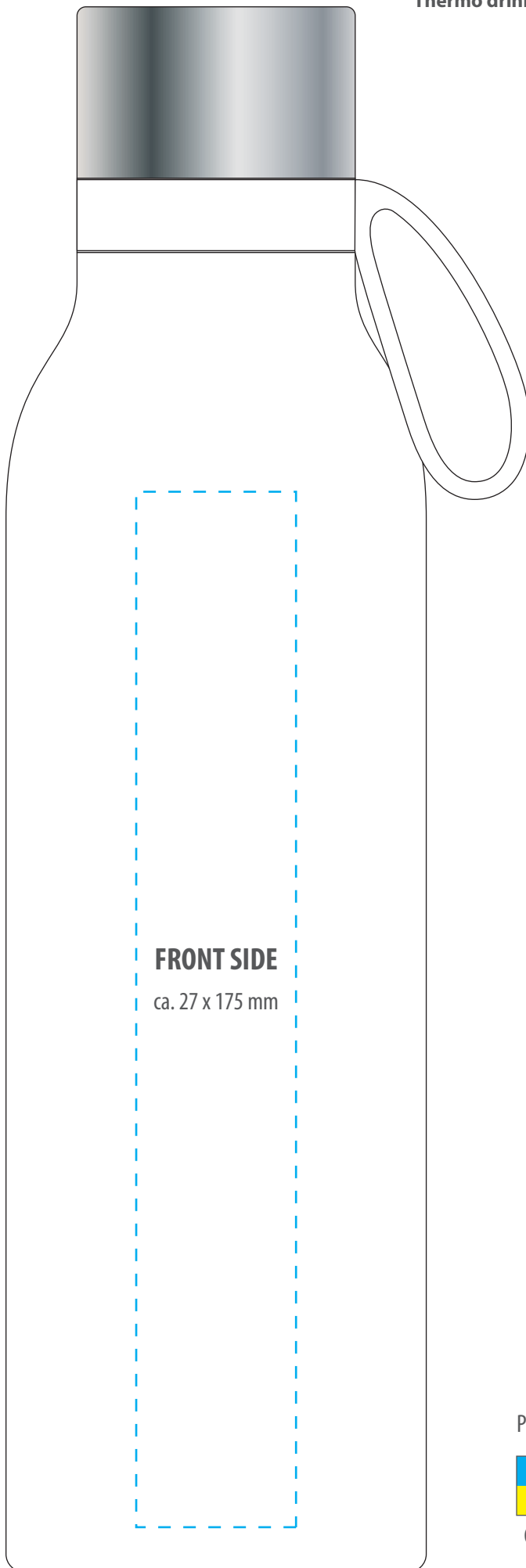

FRONT SIDE
ca. 27 x 175 mm

Printing colors:



CMYK

Configuration:

BOTTLE:
52655-X

RING:
52457-R

UV DIGITAL PRINT (UVD)

52655
RETUMBLER-myNIZZA II 600 CERAMIC



Thermo drinking bottle

52655-BK AND -WE ONLY!

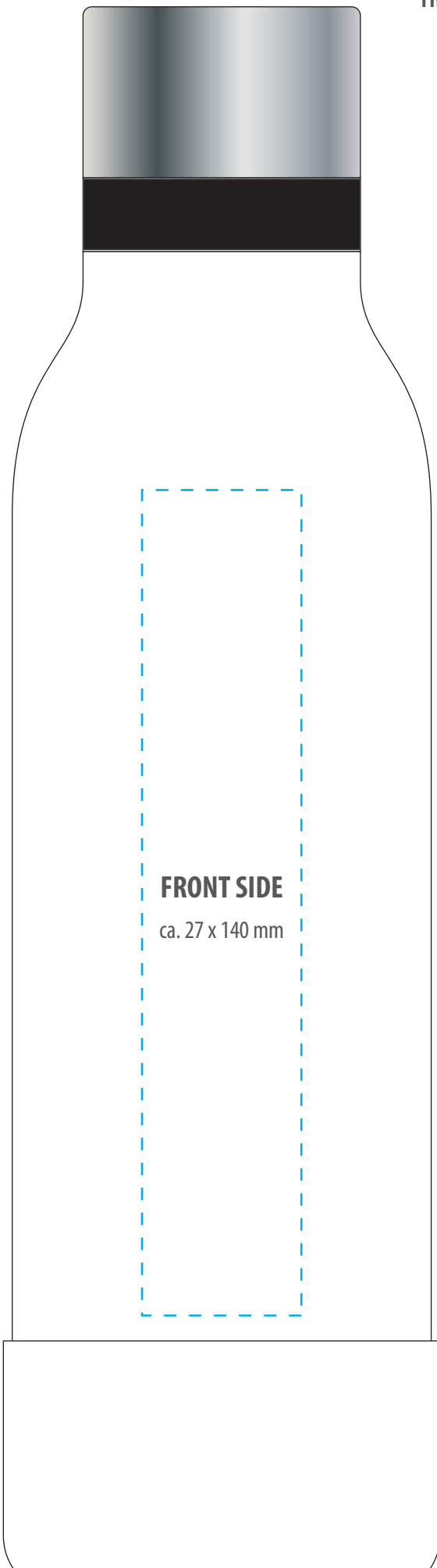

FRONT SIDE

ca. 27 x 140 mm

Printing colors:



CMYK

Configuration:

BOTTLE
+ RING:
52655-X

SLEEVE:
52457-S

UV DIGITAL PRINT (UVD)

52655
RETUMBLER-NIZZA II 600 CERAMIC

Thermo drinking bottle

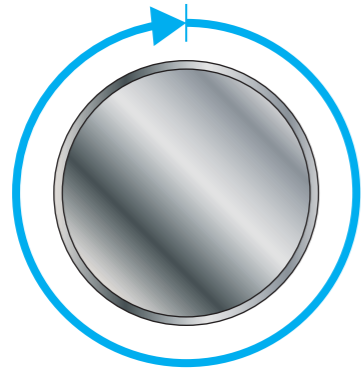

WRAP AROUND
ca. 223 x 175 mm

Printing colors:



CMYK

UV WRAP AROUND PRINT (UVD)

52655
RETUMBLER-myNIZZA II 600 CERAMIC

Thermo drinking bottle

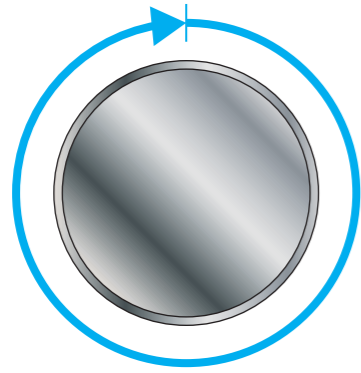

WRAP AROUND
ca. 223 x 135 mm

Printing colors:



CMYK

Configuration:

- BOTTLE:
52655-X
- RING:
52457-R
- SLEEVE:
52457-S

UV WRAP AROUND PRINT (UVD)

52655
RETUMBLER-myNIZZA II 600 CERAMIC

Thermo drinking bottle



UV WRAP AROUND PRINT (UVD)

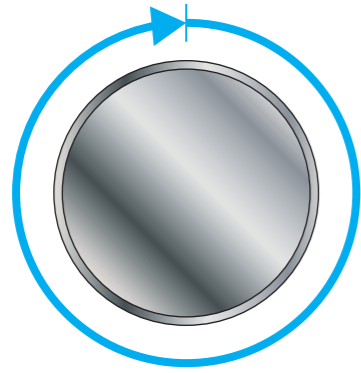

WRAP AROUND
ca. 223 x 175 mm

Printing colors:



CMYK

Configuration:

- BOTTLE:
52655-X
- RING:
52457-R

52655
RETUMBLER-myNIZZA II 600 CERAMIC

Thermo drinking bottle



UV WRAP AROUND PRINT (UVD)

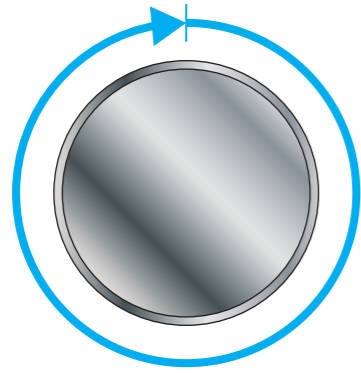

WRAP AROUND
ca. 223 x 135 mm

Printing colors:



CMYK

Configuration:

- BOTTLE
+ RING:
52655-X
- SLEEVE:
52457-S

52655
RETUMBLER-NIZZA II 600 CERAMIC

Thermo drinking bottle

180°
UVD

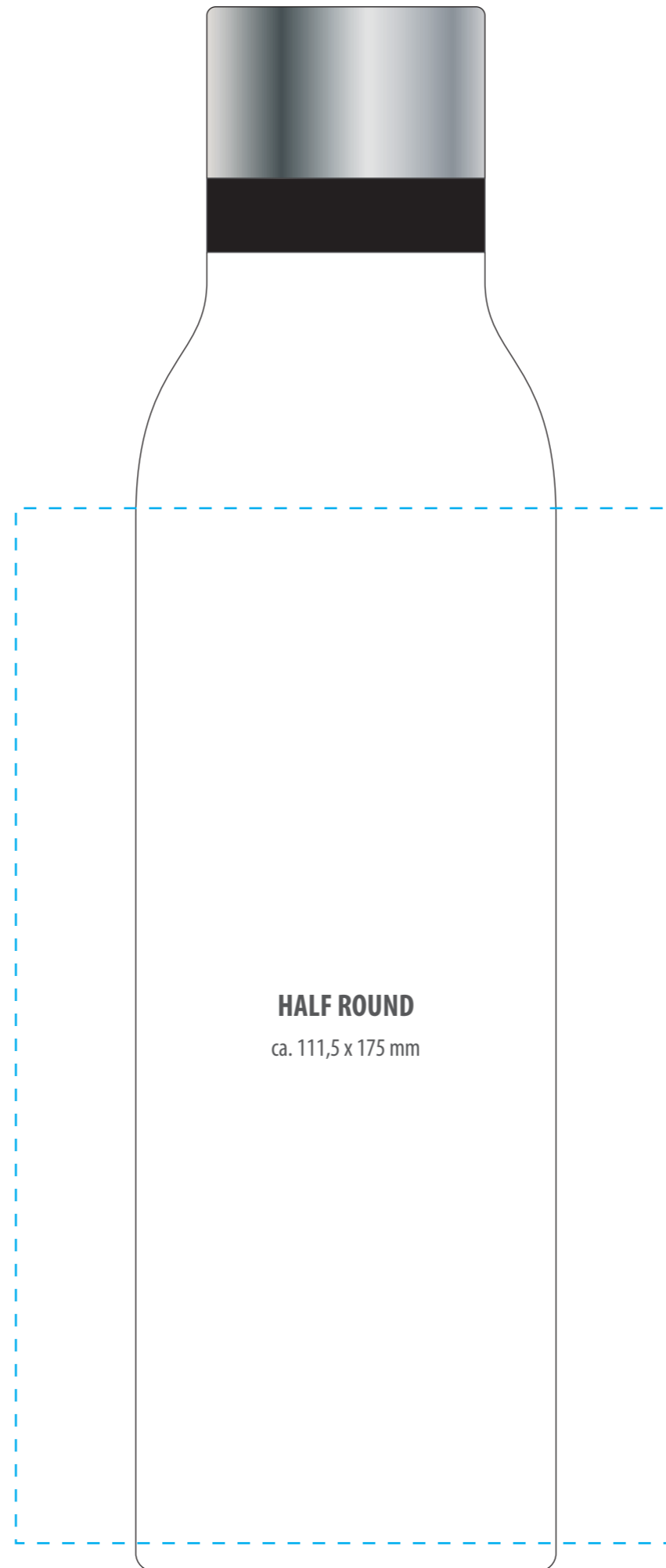
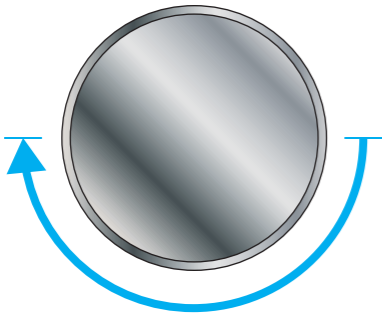

HALF ROUND
ca. 111,5 x 175 mm

Printing colors:



CMYK

UV WRAP AROUND PRINT (UVD)

52655
RETUMBLER-myNIZZA II 600 CERAMIC

Thermo drinking bottle

180°
UVD

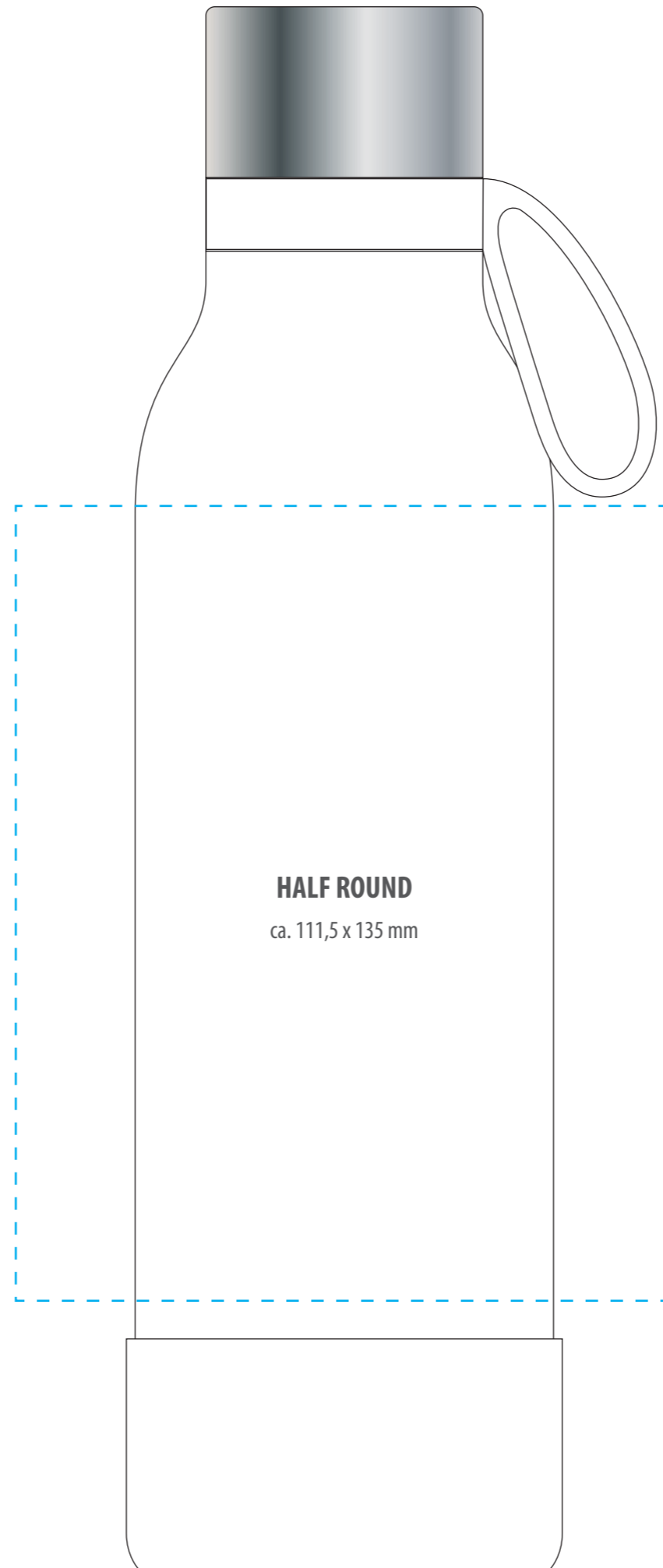
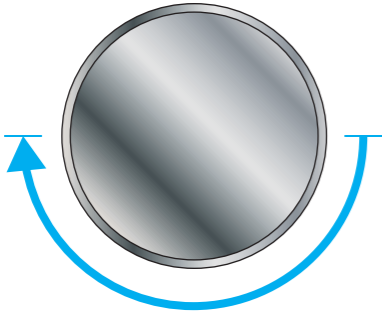

Printing colors:



CMYK

Configuration:

- BOTTLE:
52655-X
- RING:
52457-R
- SLEEVE:
52457-S

UV WRAP AROUND PRINT (UVD)

52655
RETUMBLER-myNIZZA II 600 CERAMIC

Thermo drinking bottle

180°
UVD

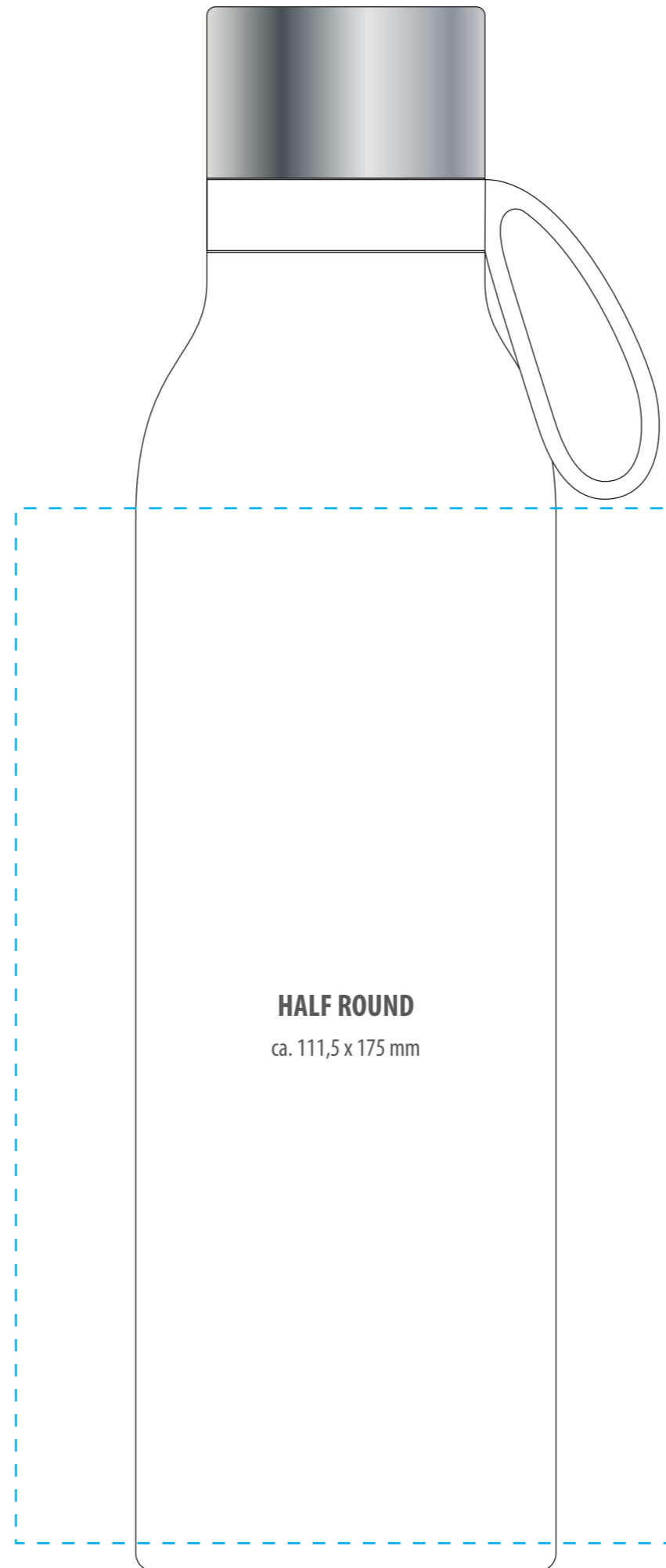
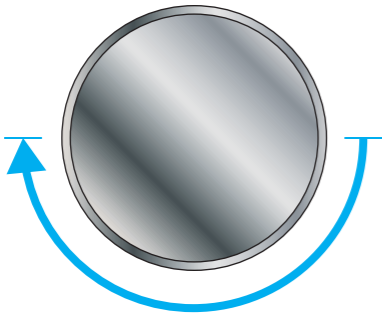

HALF ROUND
ca. 111,5 x 175 mm

Printing colors:



CMYK

Configuration:

BOTTLE:
52655-X

RING:
52457-R

UV WRAP AROUND PRINT (UVD)

52655
RETUMBLER-myNIZZA II 600 CERAMIC

Thermo drinking bottle

180°
UVD

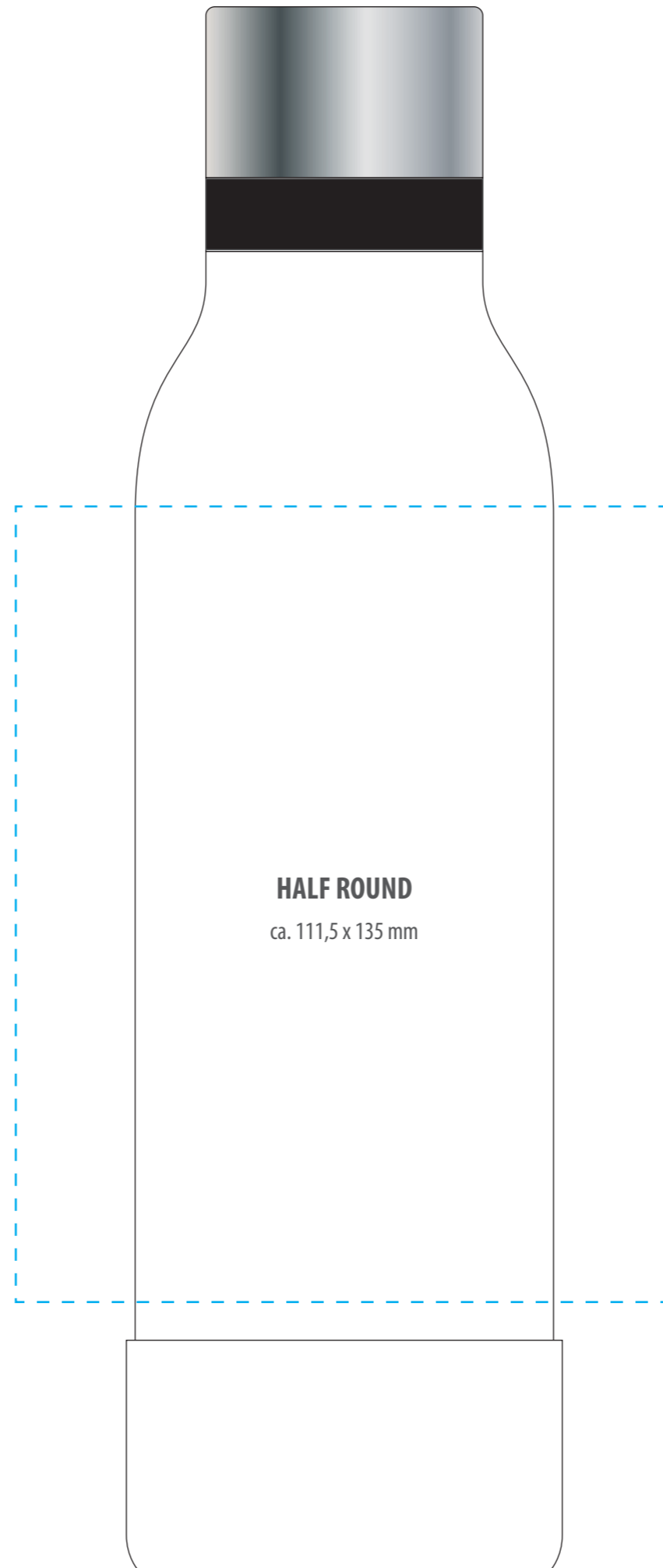
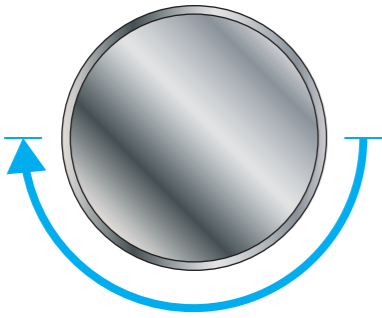

HALF ROUND
ca. 111,5 x 135 mm

Printing colors:



CMYK

Configuration:

- BOTTLE
+ RING:
52655-X
- SLEEVE:
52457-S

UV WRAP AROUND PRINT (UVD)

DE

Legende (COL)

Max. Gravurbereich

Bitte beachten Sie, daß wir aus produktionstechnischen Gründen standardgemäß eine **maximale Motivgröße** von

- **bis zu 400 mm²** oder
- **bis zu 800 mm²** anbieten.

Größere Motive müssen angefragt und auf deren Umsetzbarkeit geprüft werden.

Eine maximale Motivbreite von 140 x 140 mm darf nicht überschritten werden.

Aufgrund der Artikeloberflächenbeschaffenheit können wir eine 100%ige Farb- und Standgenauigkeit nicht garantieren. Dies gilt insbesondere für Wiederholungsaufträge.

Änderungen der Vorlagen aus technischen Gründen behalten wir uns vor!

EN

Legend (COL)

Max. engraving area

Please note that for production reasons we offer a **maximum motif size** of

- **up to 400 mm²** or
- **up to 800 mm²** as standard.

Larger motifs must be requested and checked for feasibility.

A maximum motif width of 140 x 140 mm must not be exceeded.

Due to the nature of the item's surface, we cannot guarantee 100% colour and stand accuracy. This is especially true for repeat assignments.

We reserve the right to make changes to the templates for technical reasons!

52655
RETUMBLER-myNIZZA II 600 CERAMIC

Thermo drinking bottle

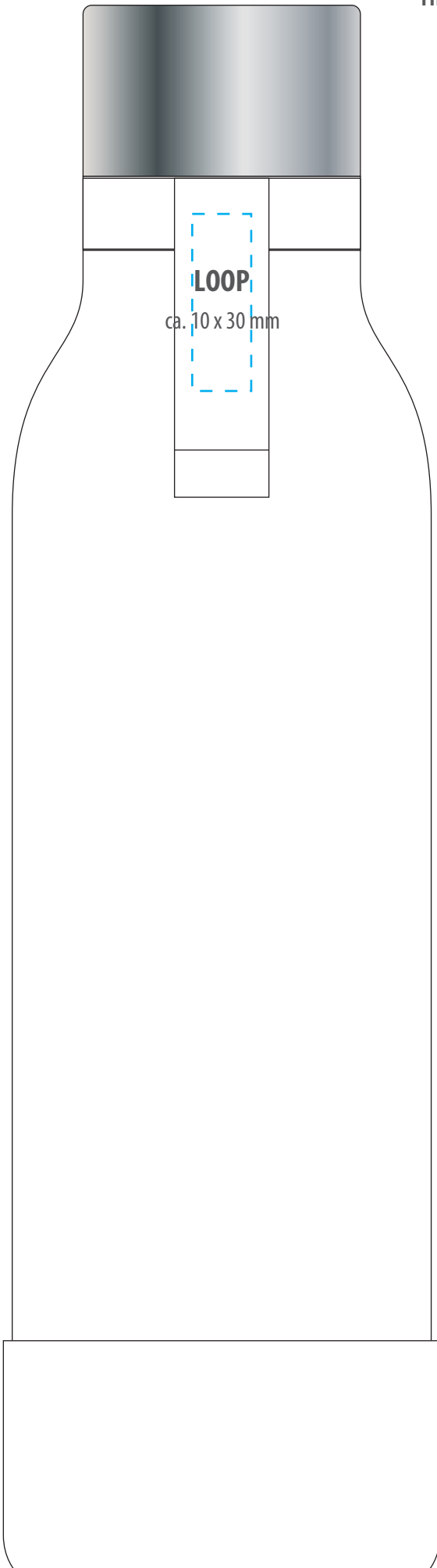

CO₂-LASER ENGRAVING (COL)

Configuration:

- BOTTLE:
52655-X
- RING:
52457-R
- SLEEVE:
52457-S

52655
RETUMBLER-myNIZZA II 600 CERAMIC

Thermo drinking bottle

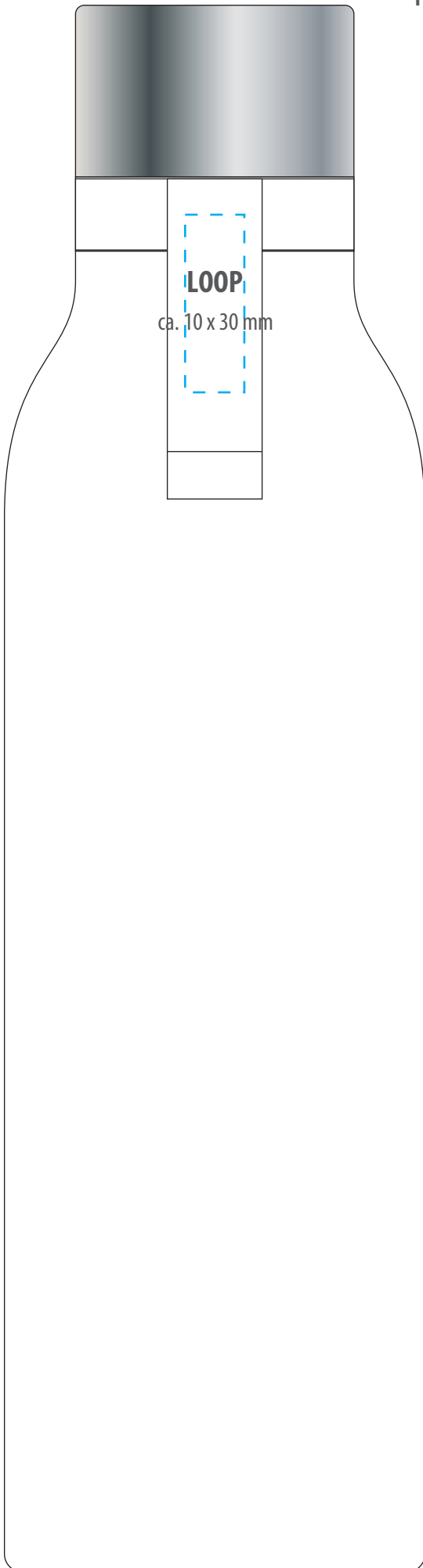

CO₂-LASER ENGRAVING (COL)

Configuration:

- BOTTLE:
52655-X
- RING:
52457-R